

- SI IP4
- SI IP67
- Bajonett
- MPP IP67
- PP IP67
- M9 IP40
- M9 IP67
- SI IP67
- Bajonett
- NCC
- PP IP67
- M16 IP40
- M16 IP67
- M23
- Bajonett
- M25
- RD24
- RD30
- M5
- M8
- M12-A
- VL
- Verteiler
- M12-B
- M12-D
- M12-S
- M12-T
- M12-US
- M18
- 7/8"
- BFA
- BF-B
- BF-C



Bajonett Steckverbinder NCC IP67

Bayonet connectors NCC IP67

Eigenschaften

- Steckverbinder mit Bajonettverriegelung
- Schutzart Kabelteil im gesteckten und verriegelten Zustand IP67 ¹⁾
- Schutzart Flanschteil ungesteckt IP67 ¹⁾
- Kabelabgang 2,5-8 mm
- > 5000 Steckzyklen
- Einfache Montage

Characteristics

- Connector with bayonet locking
- Degree of protection of cable part IP67 ¹⁾ when mated and locked correctly
- Degree of protection of socket part when not connected IP67 ¹⁾
- Cable outlet 2,5-8 mm
- > 5000 mating cycles
- Easy assembly



Aufbau des Steckverbinders:
Construction of the connector:

Kabelstecker
Male cable connector

Flanschdose
Female panel mount connector

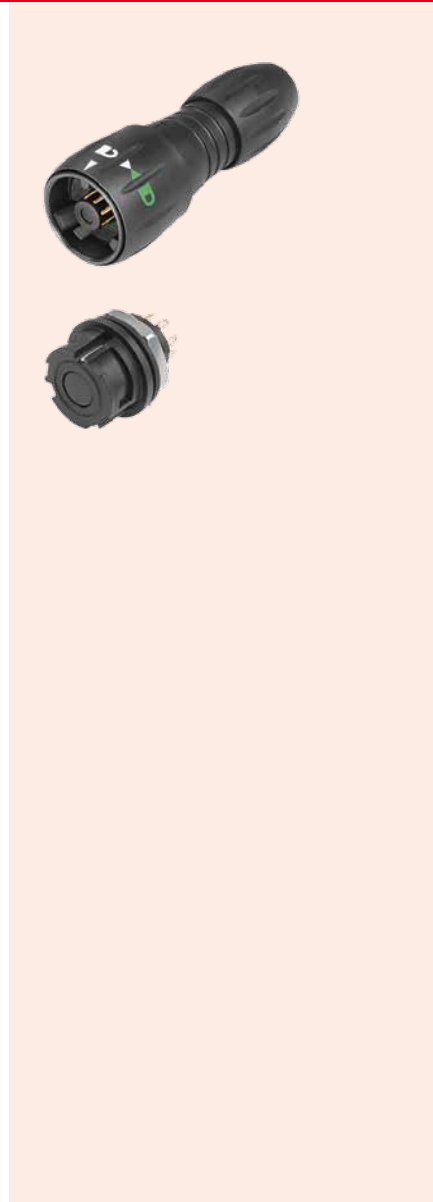

- SI IP40
- SI IP67
- Bajonett
- MPP IP67
- PP IP67
- M9 IP40
- M9 IP67
- SI IP67
- Bajonett
- NCC
- PP IP67
- M16 IP40
- M16 IP67
- M23
- Bajonett
- M25
- RD24
- RD30
- M5
- M8
- M12-A
- VL
- Verteiler
- M12-B
- M12-D
- M12-S
- M12-T
- M12-US
- M18
- 7/8"
- BF-A
- BF-B
- BF-C

Miniatursteckverbinder NCC Serie 770
Miniature Connectors NCC 770 Series

Bezeichnung Description	Kabelstecker Male cable connector	Kabelstecker Male cable connector	Kabelstecker Male cable connector
Abbildung Figure			

Maßzeichnung Drawing			
--------------------------------	--	--	--

Bestell-Nr. Ordering-No.	Polzahl Contacts	Kabeldurchlass Cable outlet	Bestell-Nr. Ordering-No.	Polzahl Contacts	Kabeldurchlass Cable outlet	Bestell-Nr. Ordering-No.	Polzahl Contacts	Kabeldurchlass Cable outlet	Bestell-Nr. Ordering-No.
	8	2,5-4 mm	99 0771 000 08	8	4-6 mm	99 0771 001 08	8	6-8 mm	99 0771 002 08

Technische Daten
Specifications

Polzahl	8	Number of contacts
Steckverbinder Verriegelung	Bajonett/bayonet	Connector locking system
Anschlussart	löten/solder	Termination
Anschlussquerschnitt	0,25 mm ² (max. AWG 24)	Wire gauge
Kabeldurchlass	2,5-4 mm, 4-6 mm, 6-8 mm	Cable outlet
Schutzart	IP67	Degree of protection
Mechanische Lebensdauer	> 5000 Steckzyklen/> 5000 mating cycles	Mechanical operation
Obere Grenztemperatur	+ 85 °C	Upper temperature
Untere Grenztemperatur	- 25 °C	Lower temperature
Bemessungsspannung	175 V	Rated voltage
Bemessungs-Stoßspannung	1750 V	Rated impulse voltage
Verschmutzungsgrad	2	Pollution degree
Überspannungskategorie	II	Overvoltage categorie
Isolierstoffgruppe	II	Material group
Bemessungsstrom (40 °C)	2 A	Rated current (40 °C)
Durchgangswiderstand	≤ 15 mΩ	Contact resistance
Material Kontakt	CuZn (Messing/brass)	Material of contact
Kontaktoberfläche	Au (Gold/gold)	Contact plating
Material Kontaktkörper	PA (UL 94 H-B)	Material of contact body
Material Gehäuse	PA (UL 94 V-0)	Material of housing

Miniatursteckverbinder NCC Serie 770
Miniature Connectors NCC 770 Series

Montageanleitung
Assembly instruction

1. Abmanteln auf L = 9mm. Ummantlung abstreifen.
2. Druckschraube, Klemmkorb, Dichtung und Abstandshülse auf Kabel auffädeln.
3. Litzen abisolieren (L = 3mm) und verzinnen.
4. Einsätze einlöten.
5. Bajonettadapter am Gewinde der Abstandshülse aufsetzen und mit leichtem Druck in Pfeilrichtung festschrauben.
6. Den Klemmkorb über den Dichting bis auf Anschlag aufschieben.
7. Mit Druckschraube Klemm-, dichteinheit gegen Abstandshülse drücken und festschrauben.

1. Strip to 9mm length and take off the cable jacket.
2. Bead pressing screw, pinch ring, seal and distance sleeve to cable.
3. Strip the insulation off the wires (L = 3mm) and tin them.
4. Solder inserts.
5. Put bayonet adapter to the thread of the distance sleeve and screw it with slight pressure in the direction of the arrow.
6. Push pinch ring over sealing ring to block.
7. Push pressing screw together with clamp-sealing unit towards distance sleeve and screw tightly.

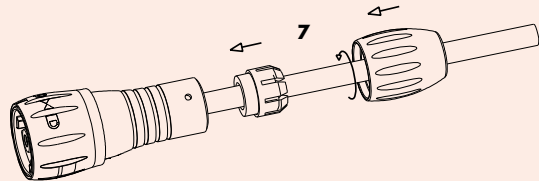
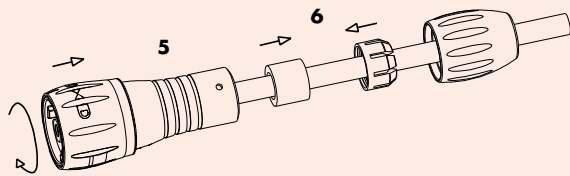
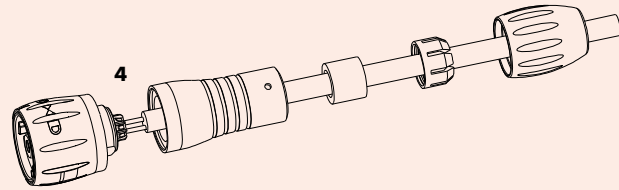
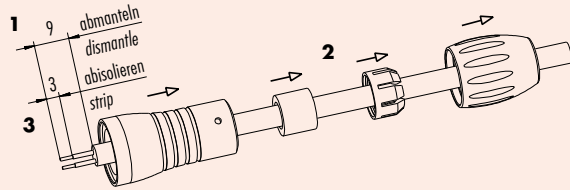

Einzelteildarstellung
Component part drawing

Kabelsteckverbinder
Cable connector

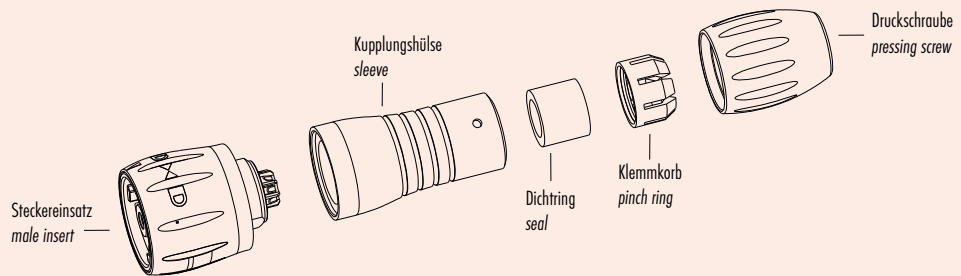

Polbilder
Contact arrangements

Stifteinsatz (Anschlussseite)
Male insert (termination side)

8 pol
8 contacts

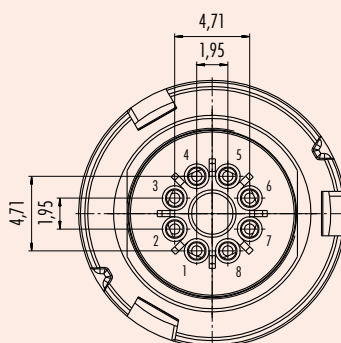

	X	Y
1	-0,98	-2,36
2	-2,36	-0,98
3	-2,36	0,98
4	-0,98	2,36
5	0,98	2,36
6	2,36	0,98
7	2,36	-0,98
8	0,98	-2,36

Miniatursteckverbinder NCC Serie 770
Miniature Connectors NCC 770 Series

Bezeichnung
Description

Flanschdose, löten
Female panel mount connector, solder

Flanschdose, tauchlöten
Female panel mount connector, dip solder

Abbildung
Figure



Maßzeichnung
Drawing

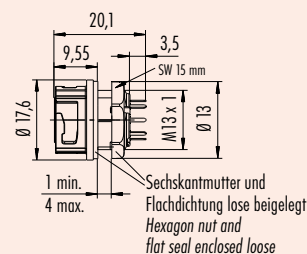
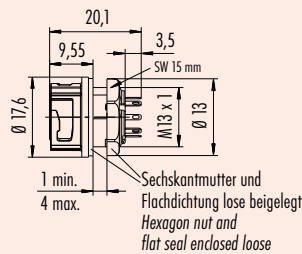

Bestell-Nr.
Ordering-No.

Polzahl Contacts	Bestell-Nr. Ordering-No.
8	09 0774 000 08

Polzahl Contacts	Bestell-Nr. Ordering-No.
8	09 0774 090 08

Technische Daten
Specifications

Polzahl	8	Number of contacts
Steckverbinder Verriegelung	Bajonett/bayonet	Connector locking system
Anschlussart	löten, tauchlöten/solder, dip solder	Termination
Anschlussquerschnitt	0,25 mm ² (max. AWG 24)	Wire gauge
Kabeldurchlass	-	Cable outlet
Schutzart	IP67 auch ungesteckt/also when not connected	Degree of protection
Mechanische Lebensdauer	> 5000 Steckzyklen/> 5000 mating cycles	Mechanical operation
Obere Grenztemperatur	+ 85 °C	Upper temperature
Untere Grenztemperatur	- 25 °C	Lower temperature
Bemessungsspannung	175 V	Rated voltage
Bemessungs-Stoßspannung	1750 V	Rated impulse voltage
Verschmutzungsgrad	2	Pollution degree
Überspannungskategorie	II	Overvoltage categorie
Isolierstoffgruppe	II	Material group
Bemessungsstrom (40 °C)	2 A	Rated current (40 °C)
Durchgangswiderstand	≤ 15 mΩ	Contact resistance
Material Kontakt	CuSn (Bronze/bronze)	Material of contact
Kontaktoberfläche	Au (Gold/gold)	Contact plating
Material Kontaktkörper	PA (UL 94 V-0)	Material of contact body
Material Gehäuse	PA (UL 94 H-B)	Material of housing

Miniatursteckverbinder NCC Serie 770
Miniature Connectors NCC 770 Series

Einzelteildarstellung
 Component part drawing

Flanschsteckverbinder
 Female panel mount connectors

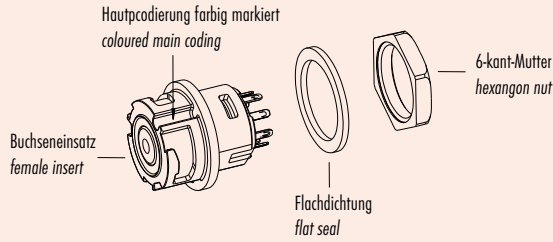

Polbilder
 Contact arrangements

Buchseneinsatz (Anschlussseite)
 Female insert (termination side)

8 pol
 8 contacts

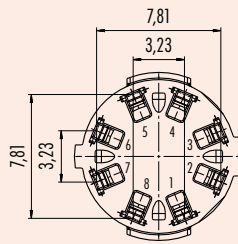

	X	Y
1	1,62	-3,90
2	3,90	-1,62
3	3,90	1,62
4	1,62	3,90
5	-1,62	3,90
6	-3,90	1,62
7	-3,90	-1,62
8	-1,62	-3,90

Montageausschnitt
 Panel cut out

